

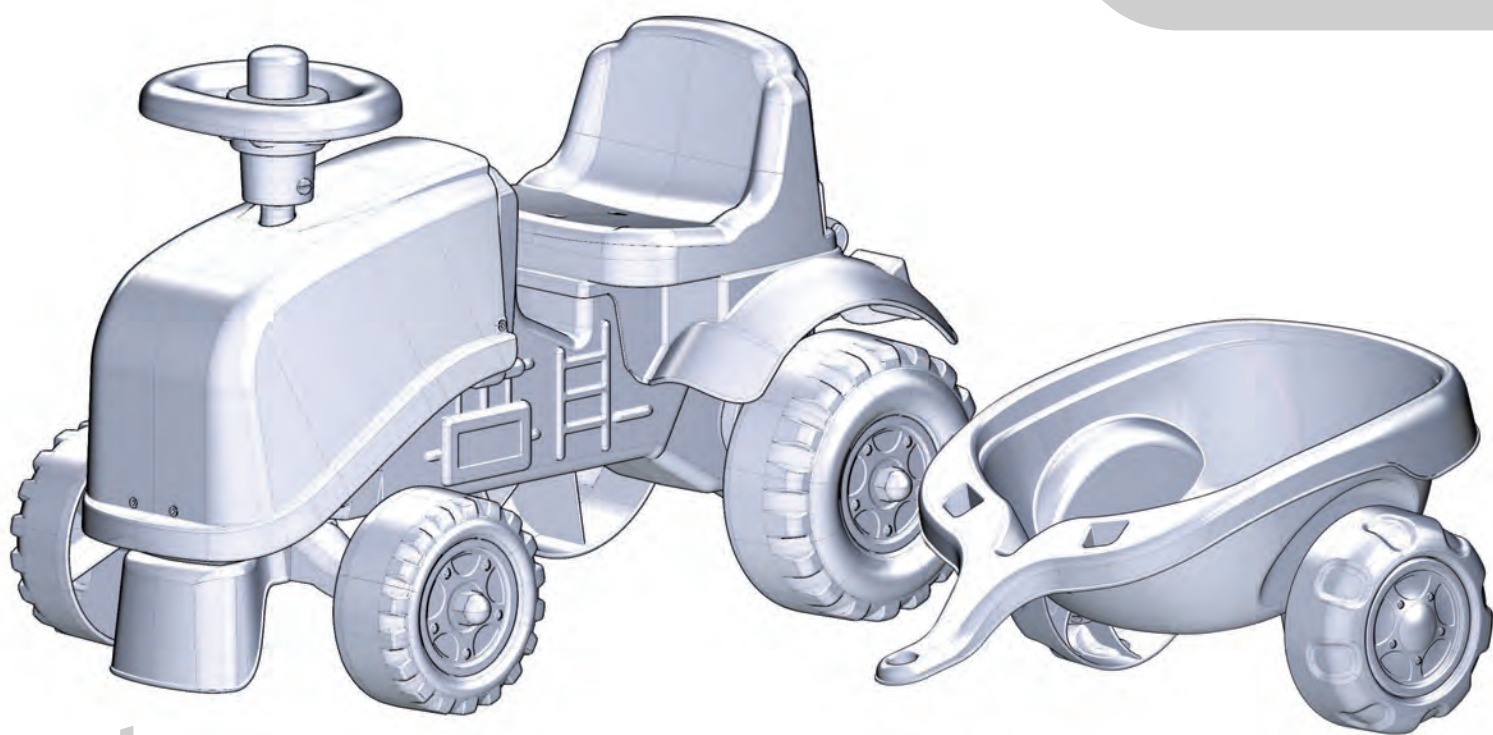

FA212C
INSTRUCTION
MANUAL



FALK USA / AHM
602 Sidwell Court Unit F,
Saint Charles, IL 60174
Tel: (630) 377-2290
Email : contact@falk-toys.us
www.falk-toys.us



FOLLOW US!



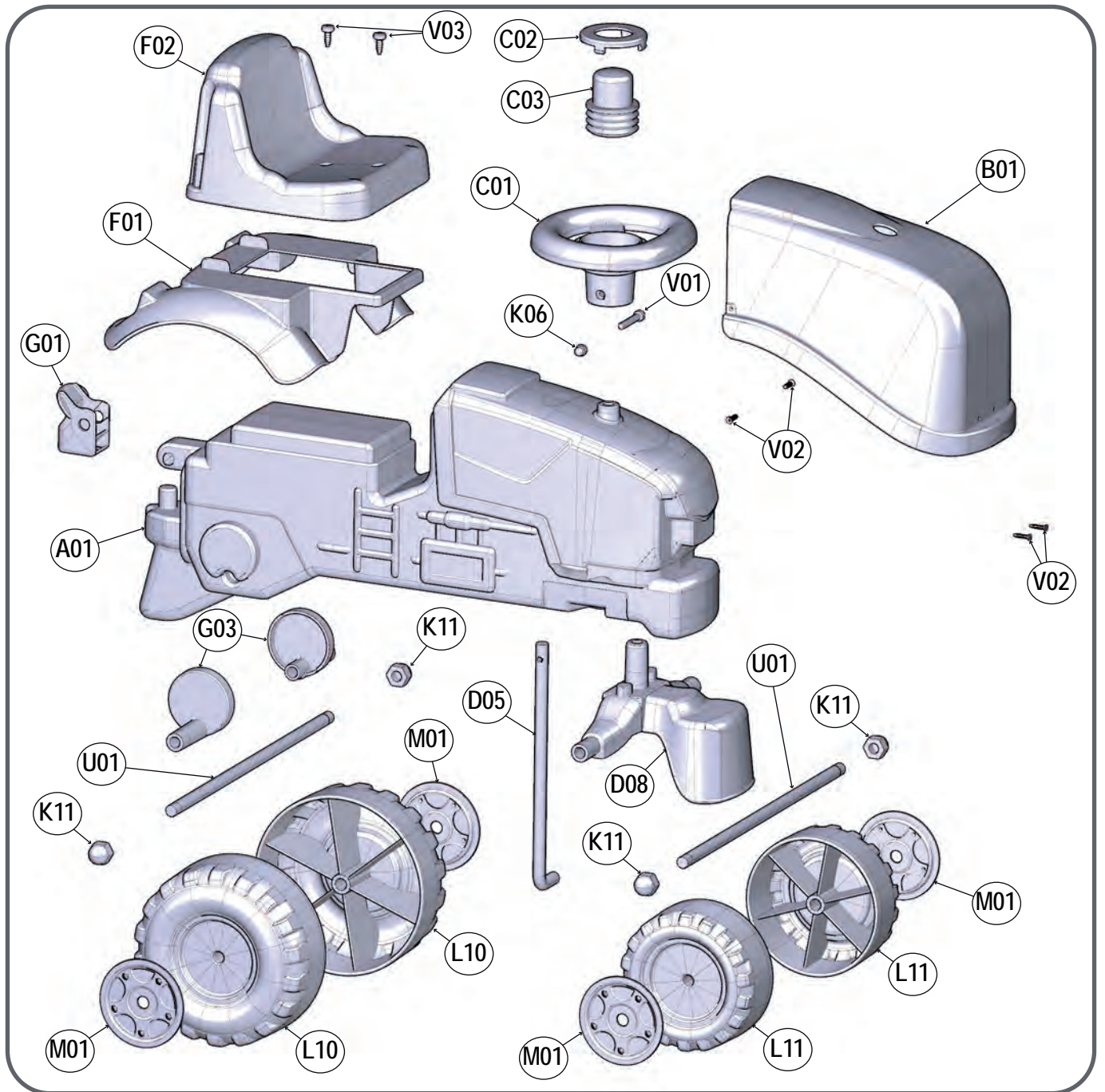

V01	V02	V03	K06	K11	G01	C02	C03	G03
Ø5 x 35 mm x 1	Ø3 x 16 mm x 4	Ø5 x 16 mm x 2	M5 x 1	M10 x 4	x 1	x 1	x 1	x 2

Z05
x 2



Tools not provided - Outils non fournis
Werkzeuge nicht geliefert

U01		x 2
Ø10 mm x 320 mm		

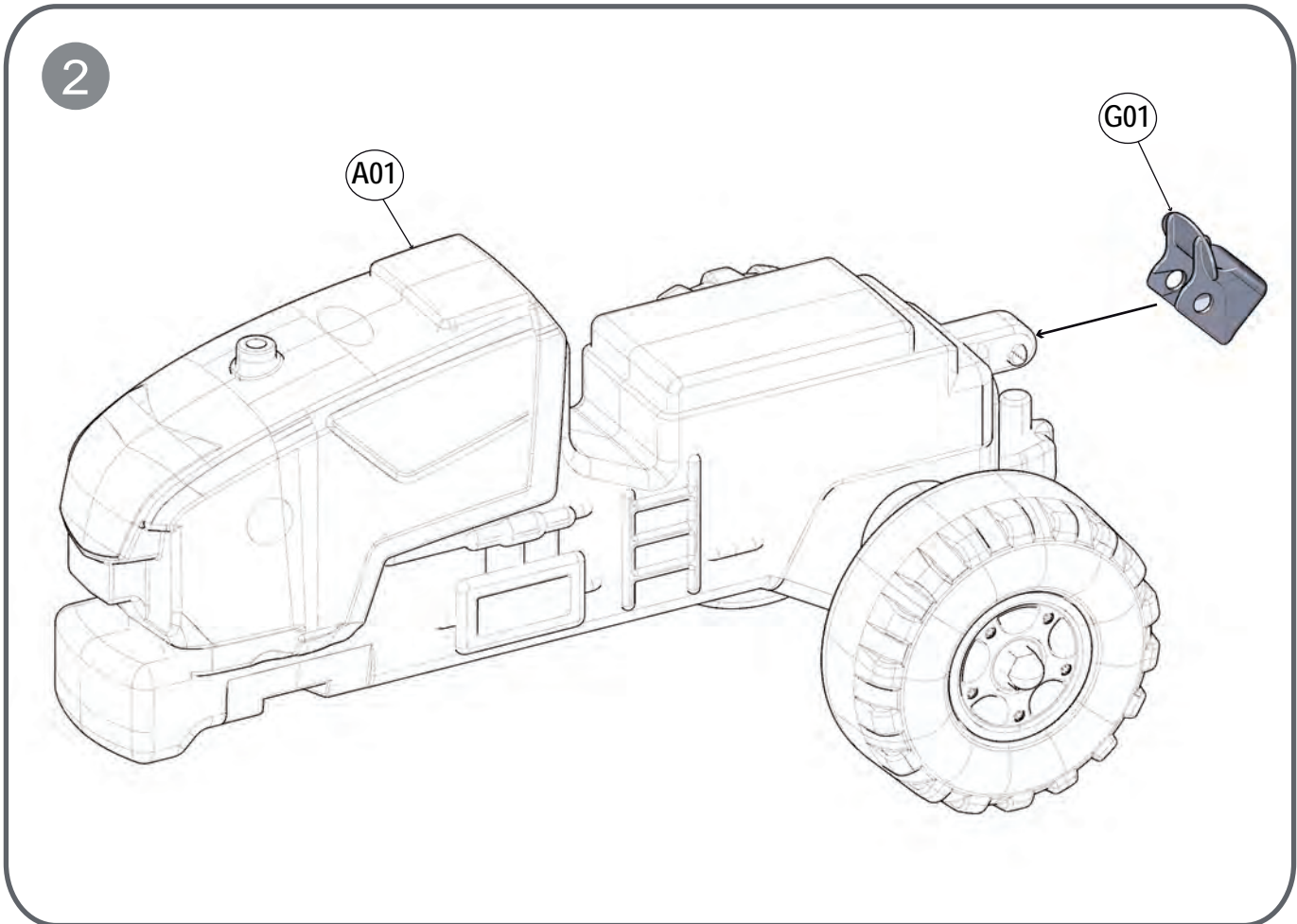
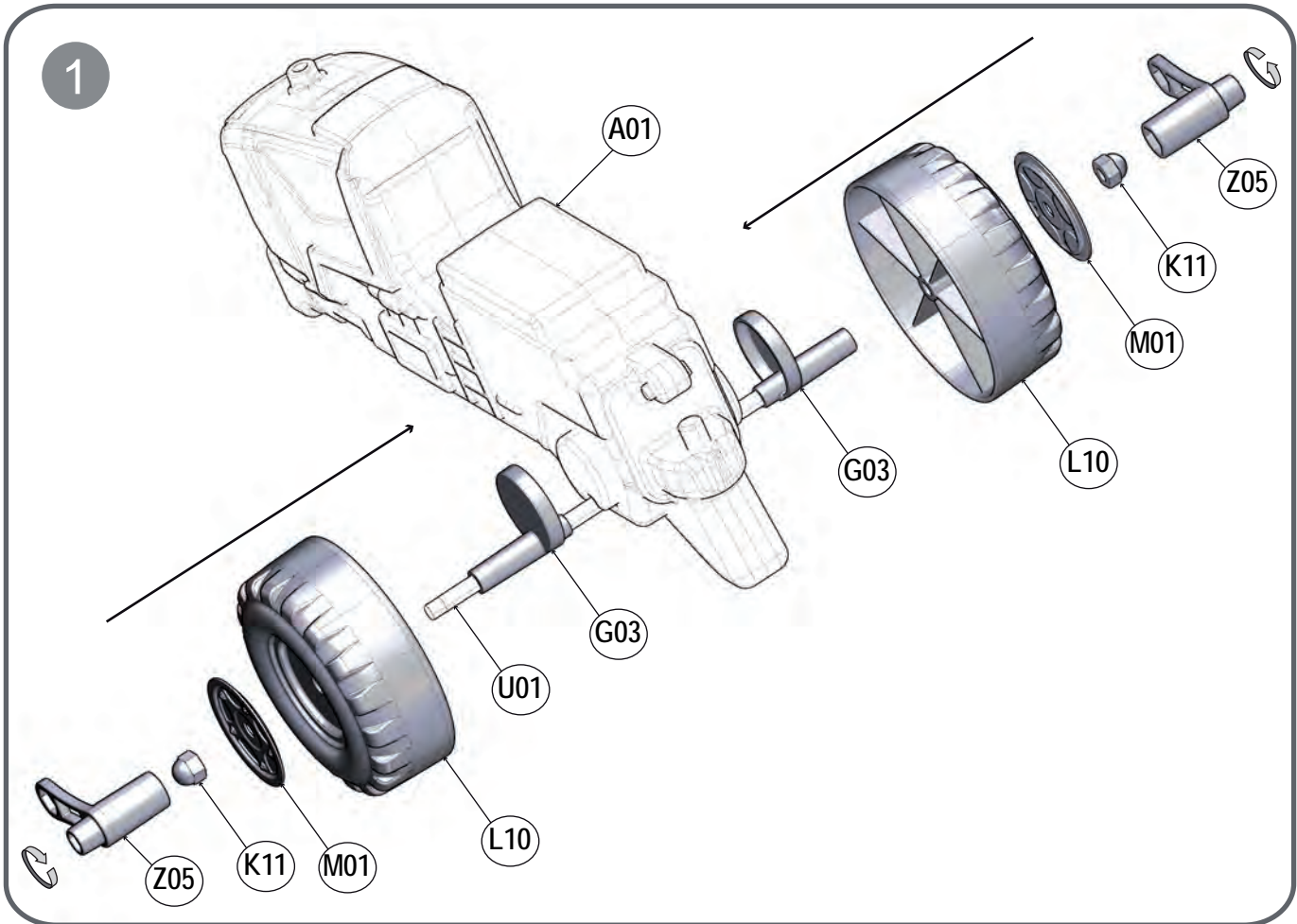

3

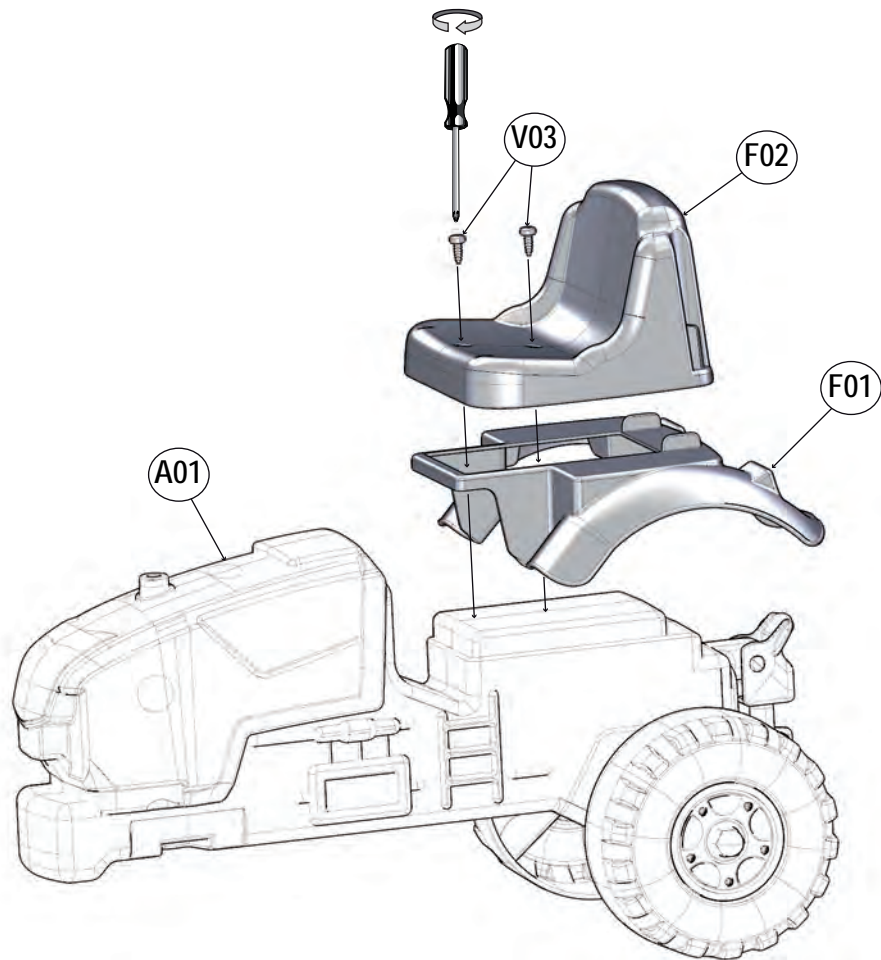

4

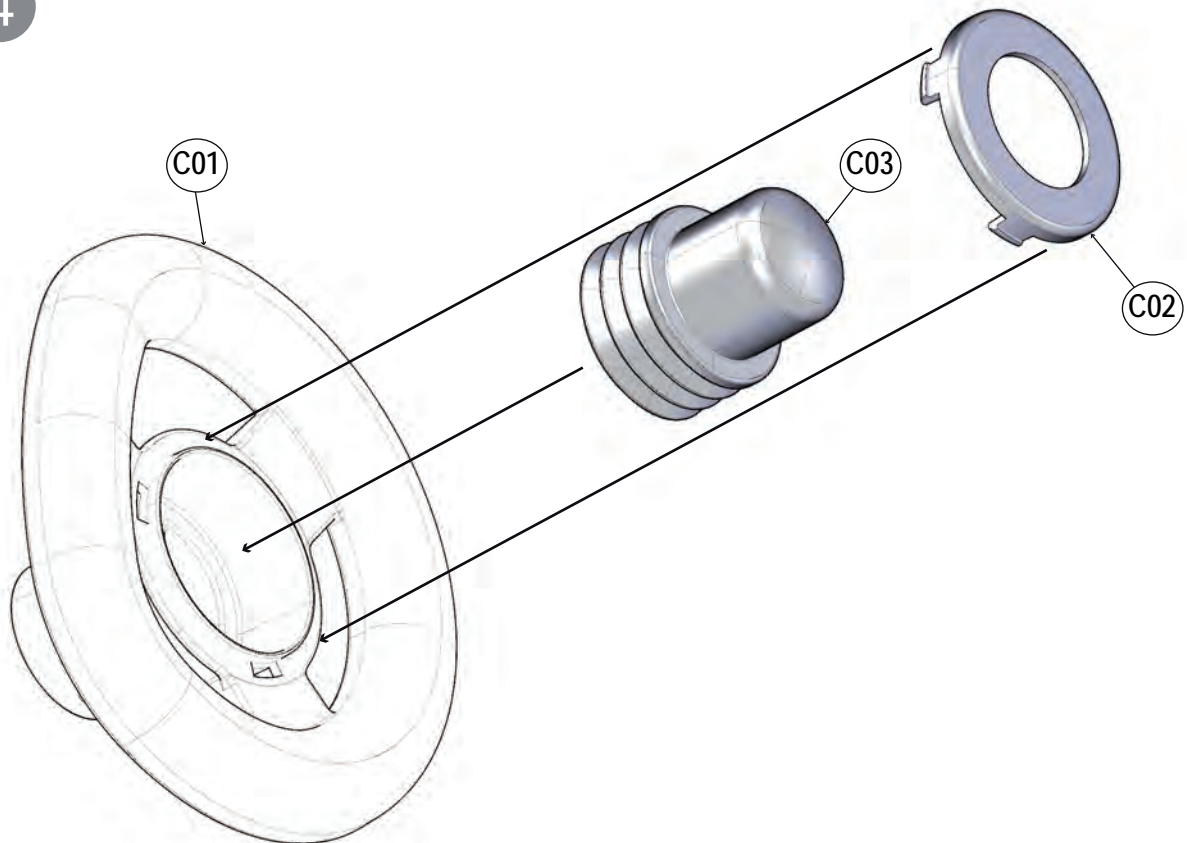

5

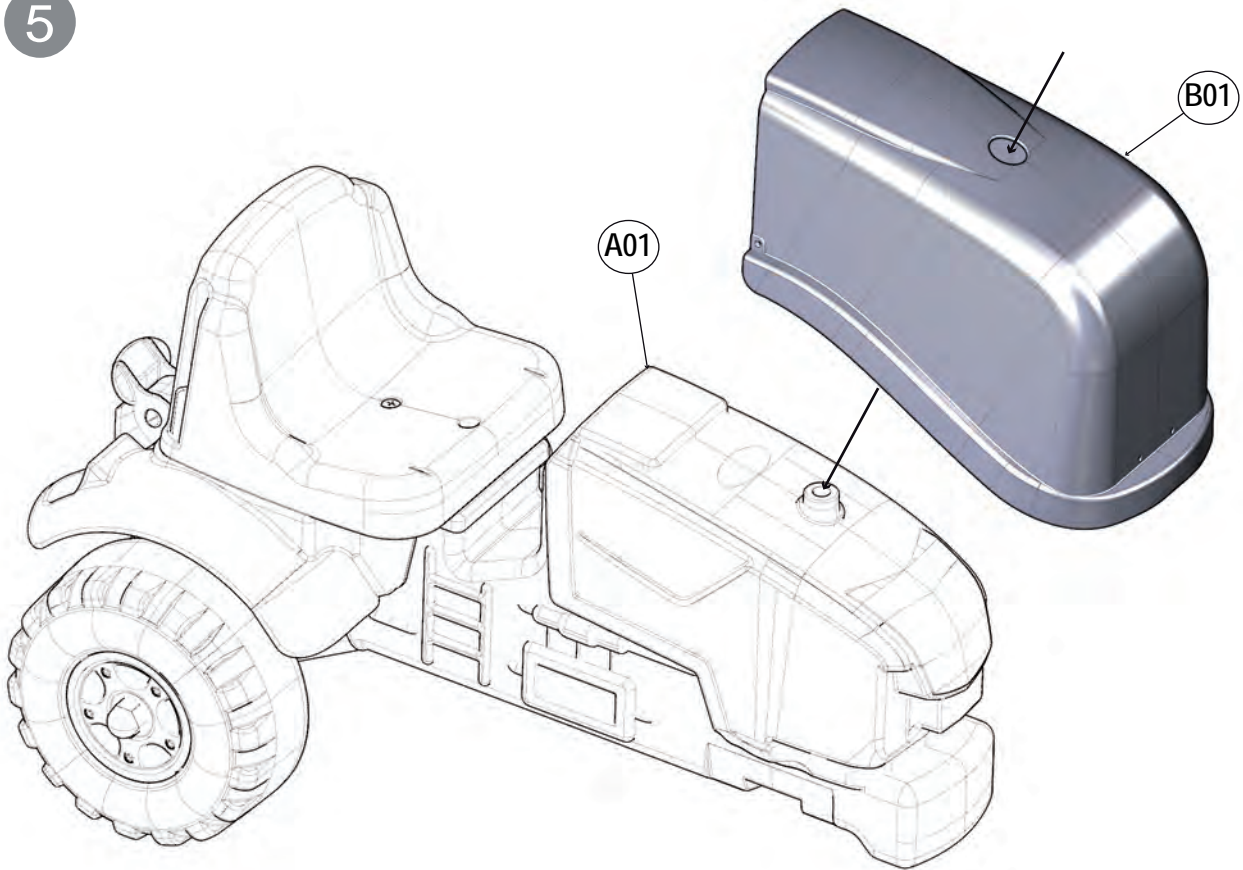

6

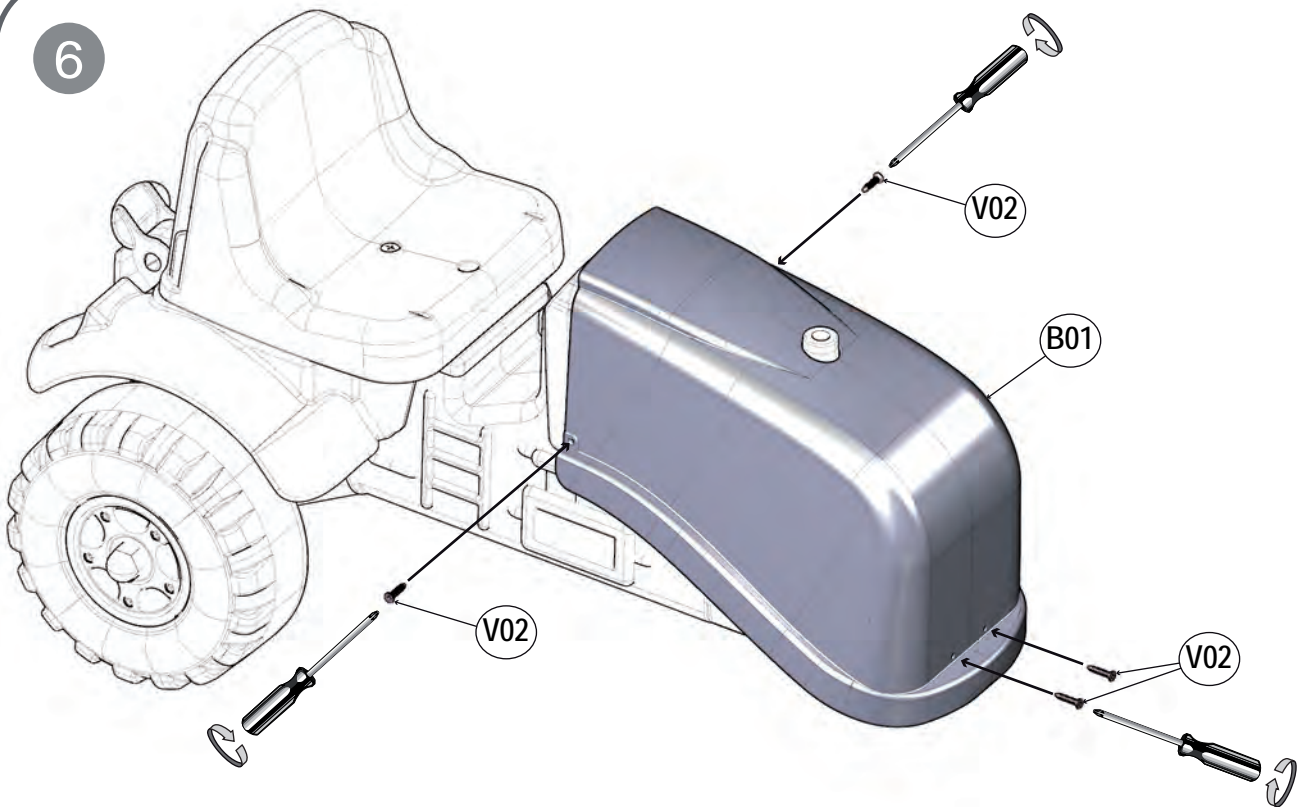

7

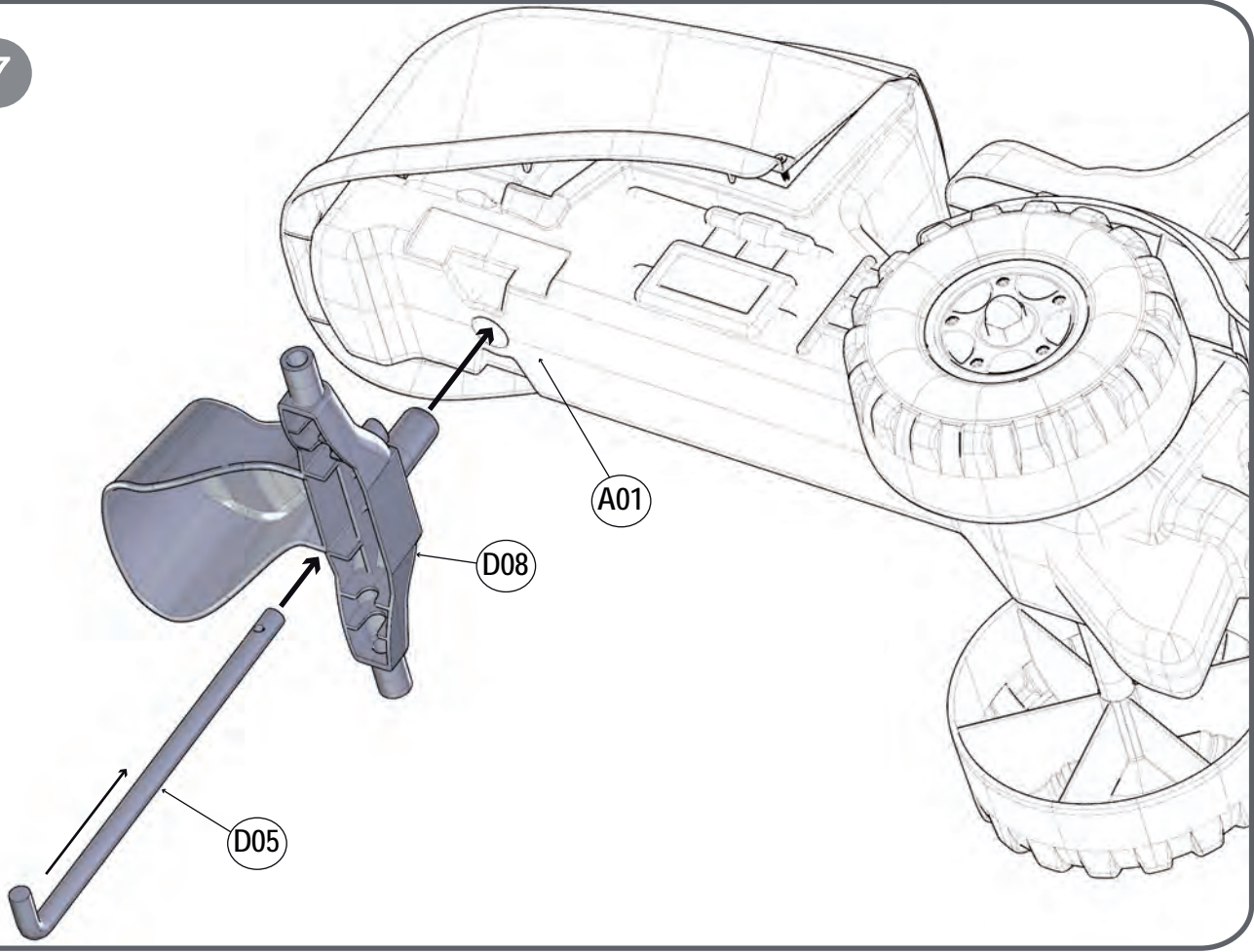

8

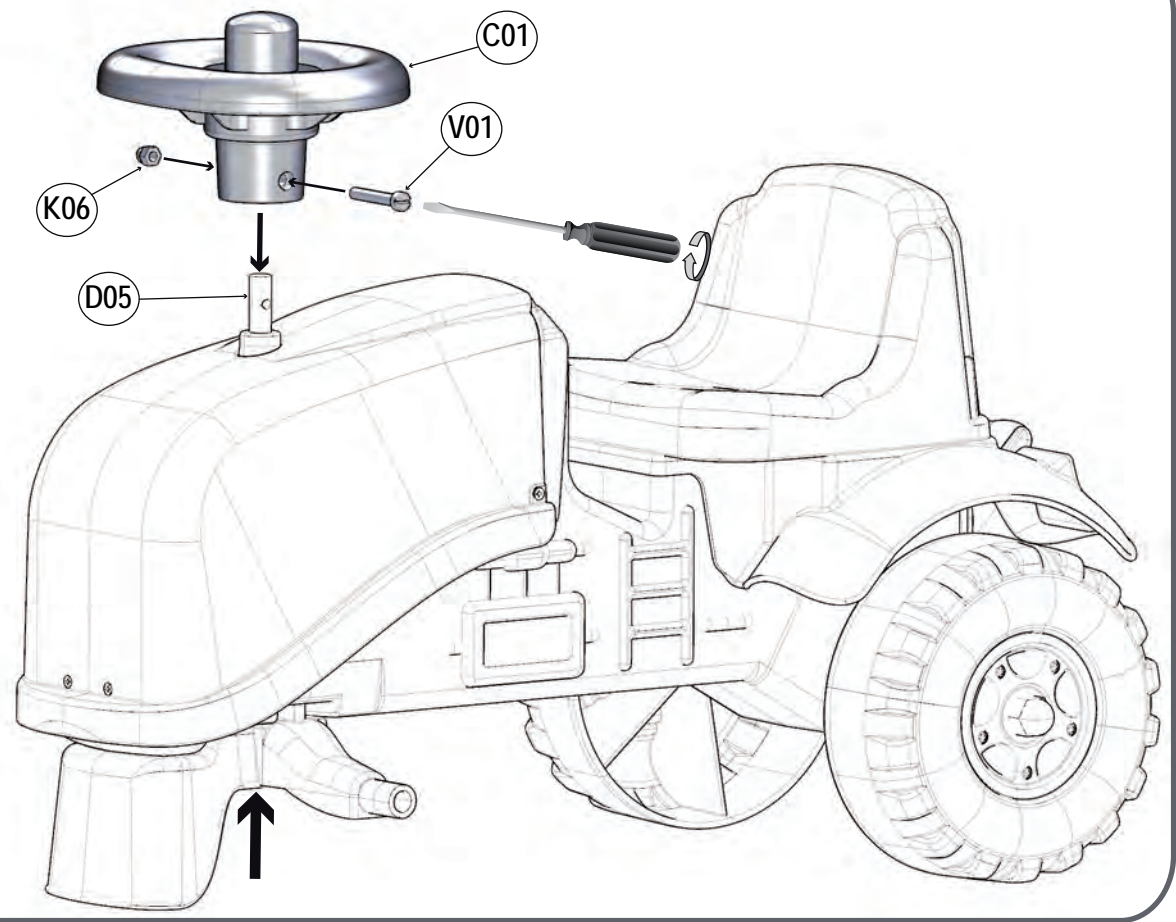

9

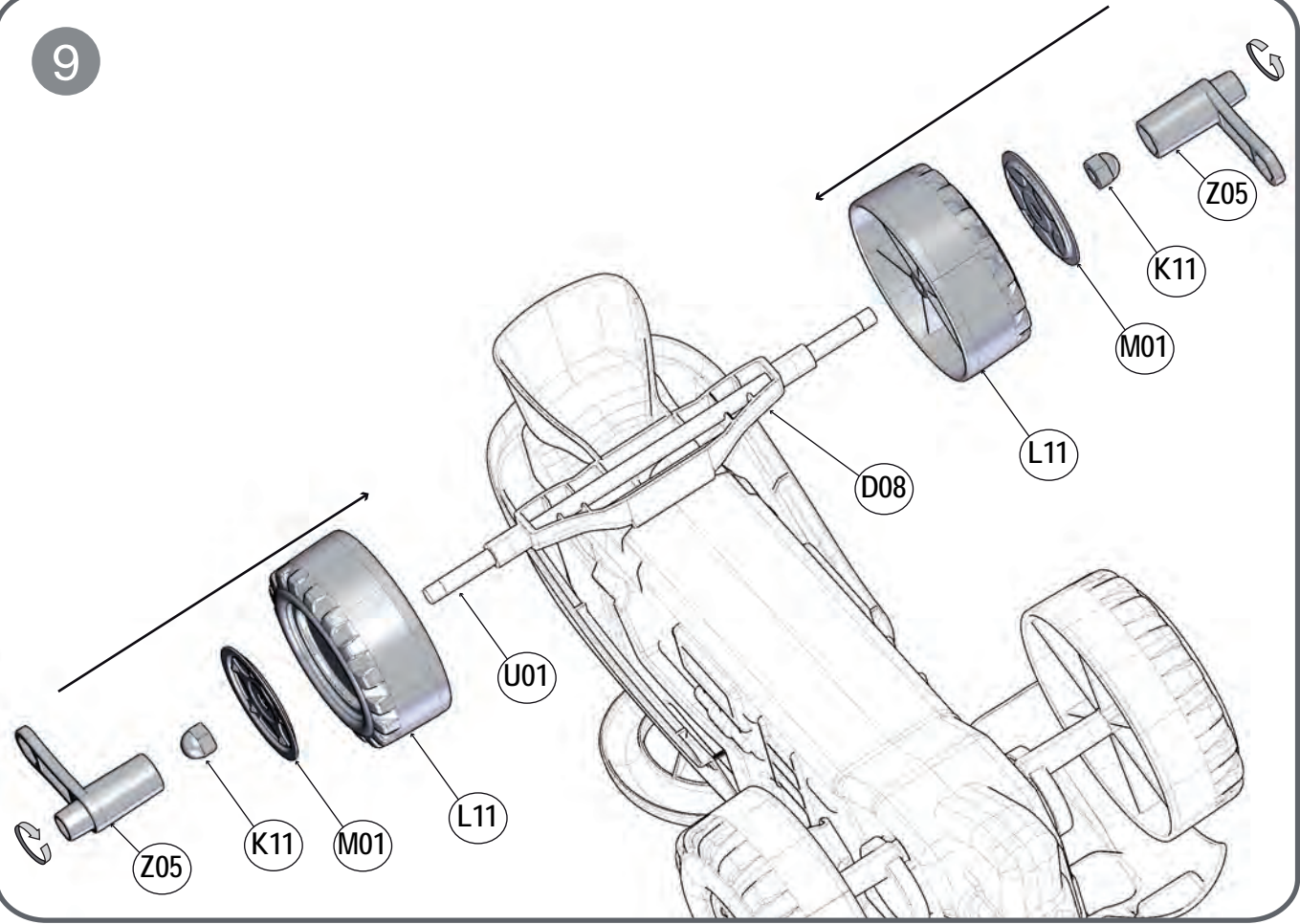

10

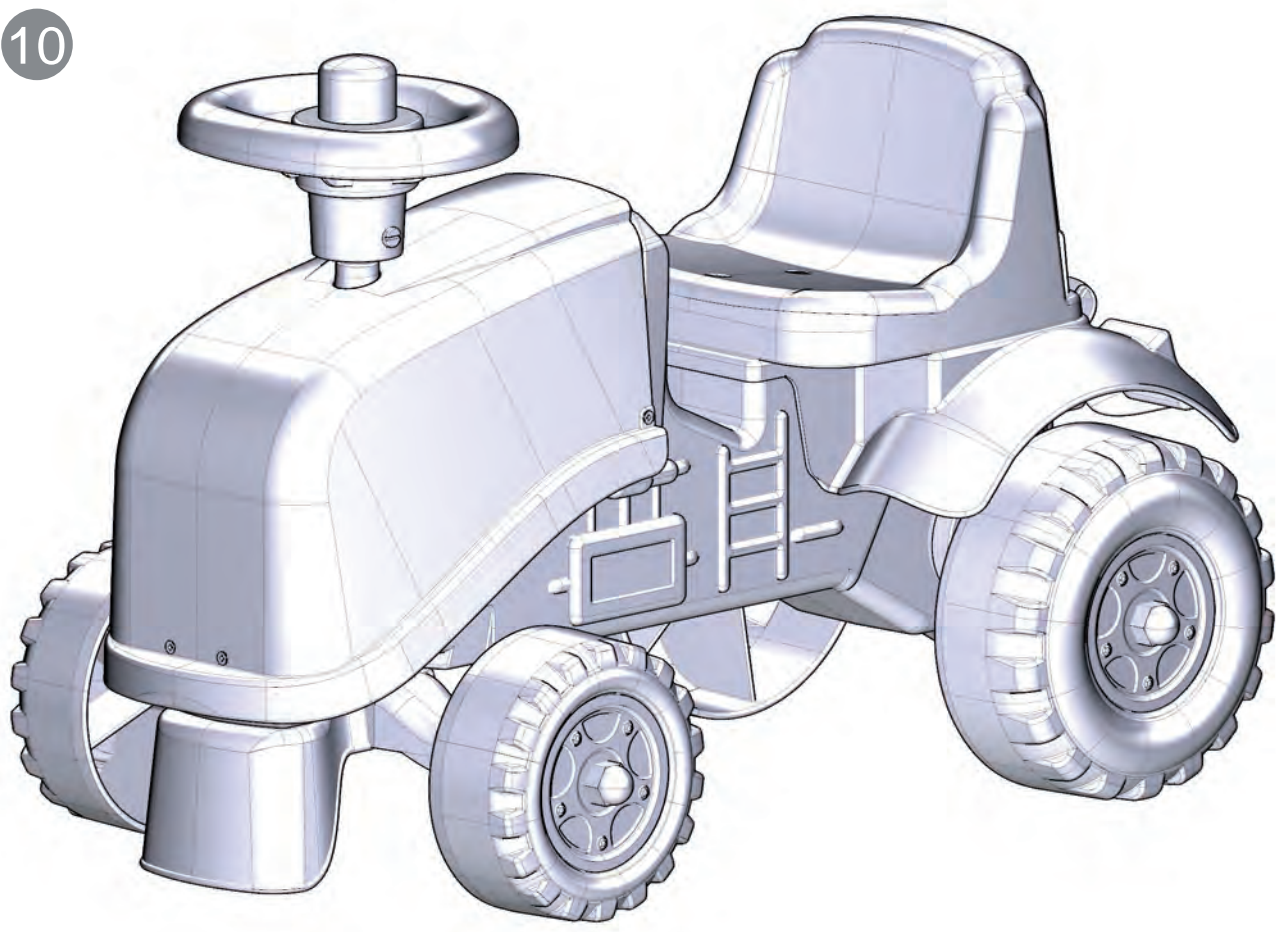

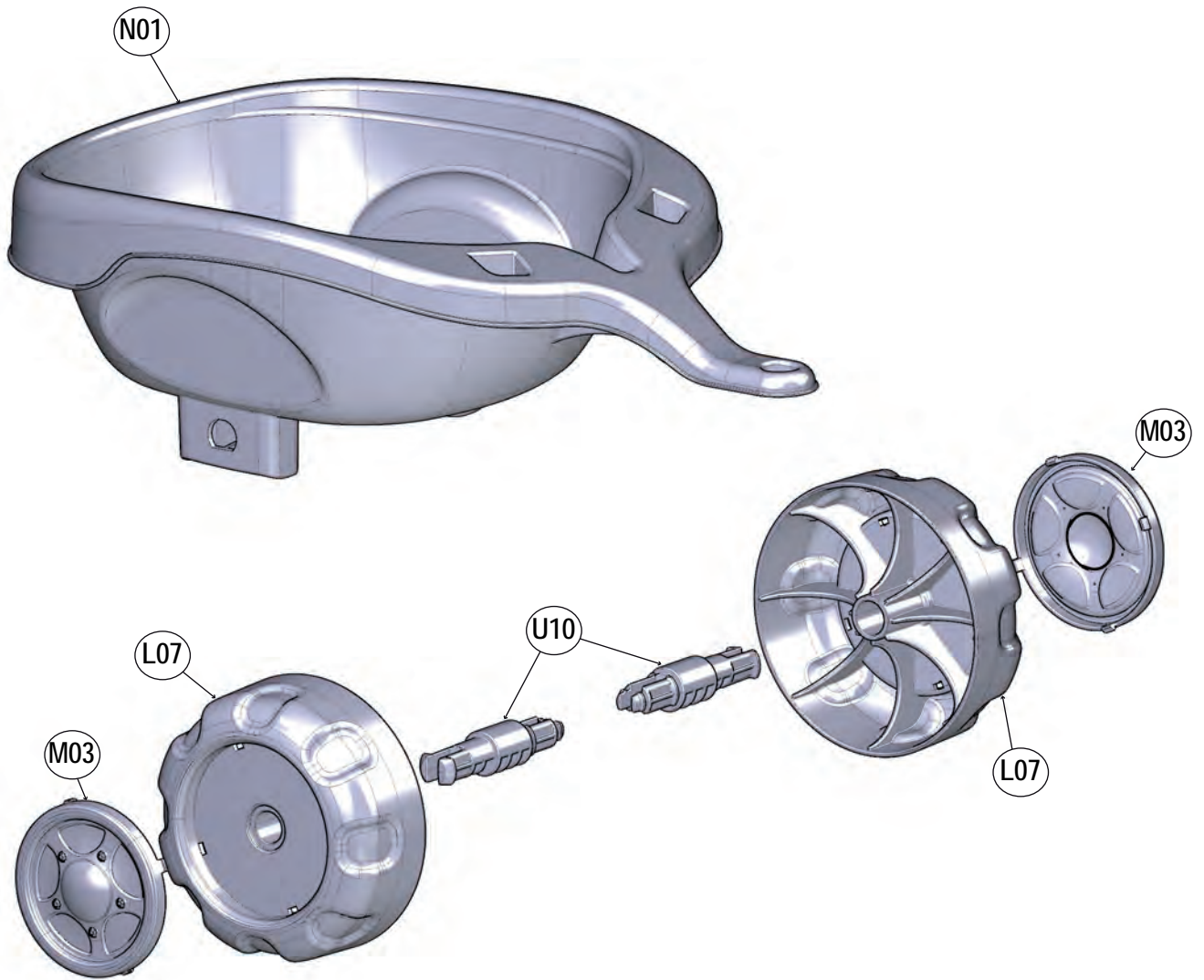

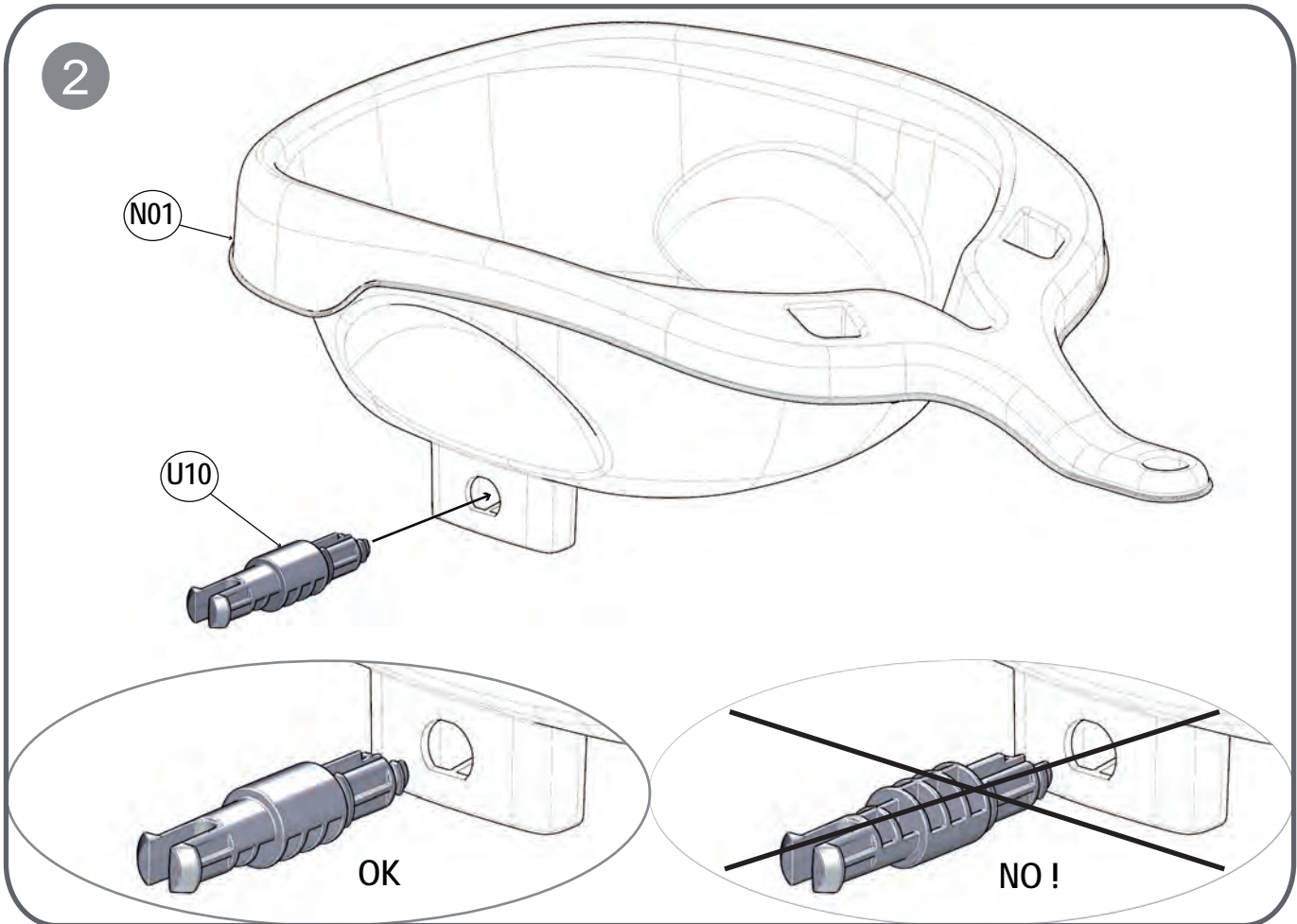
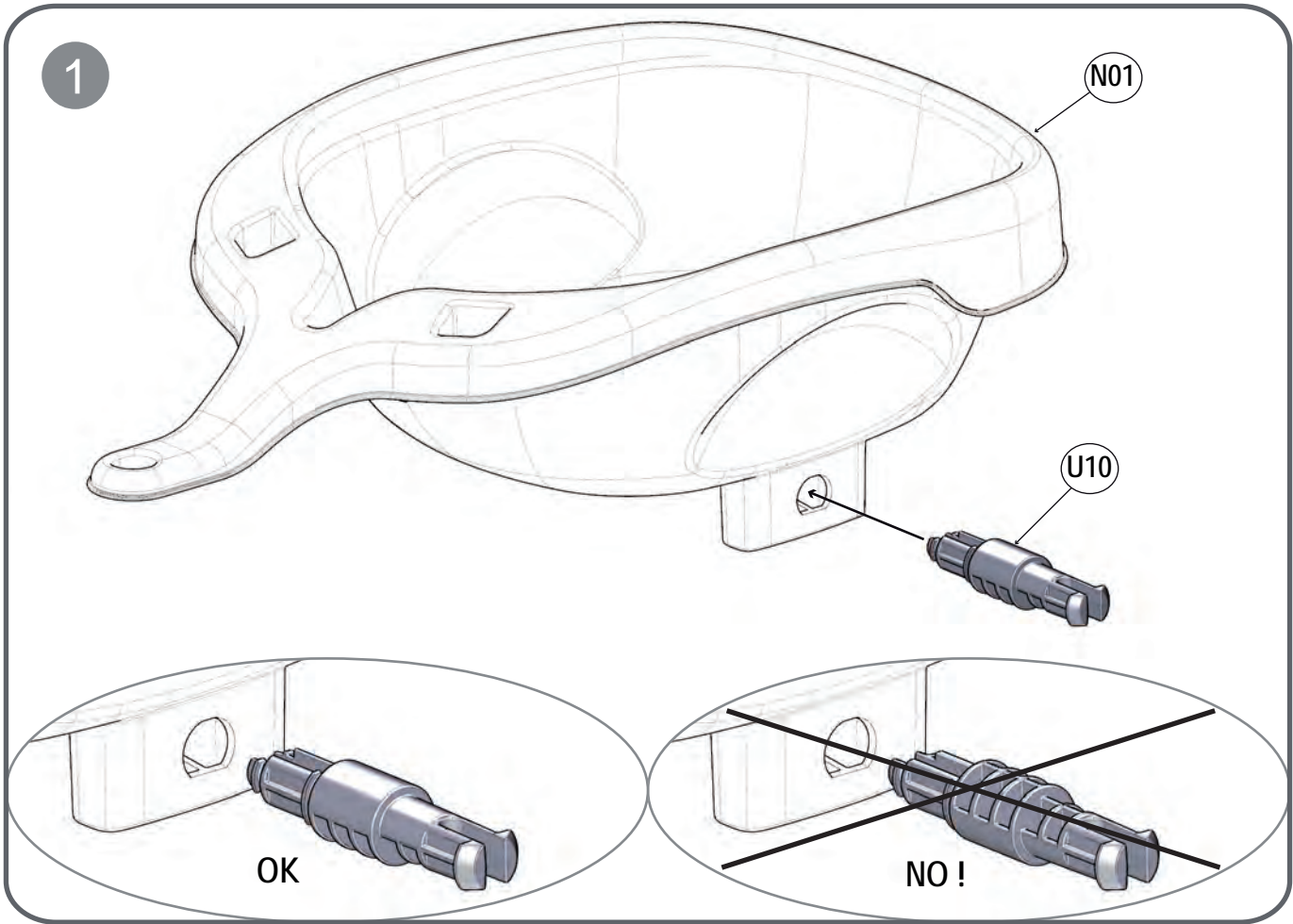

3

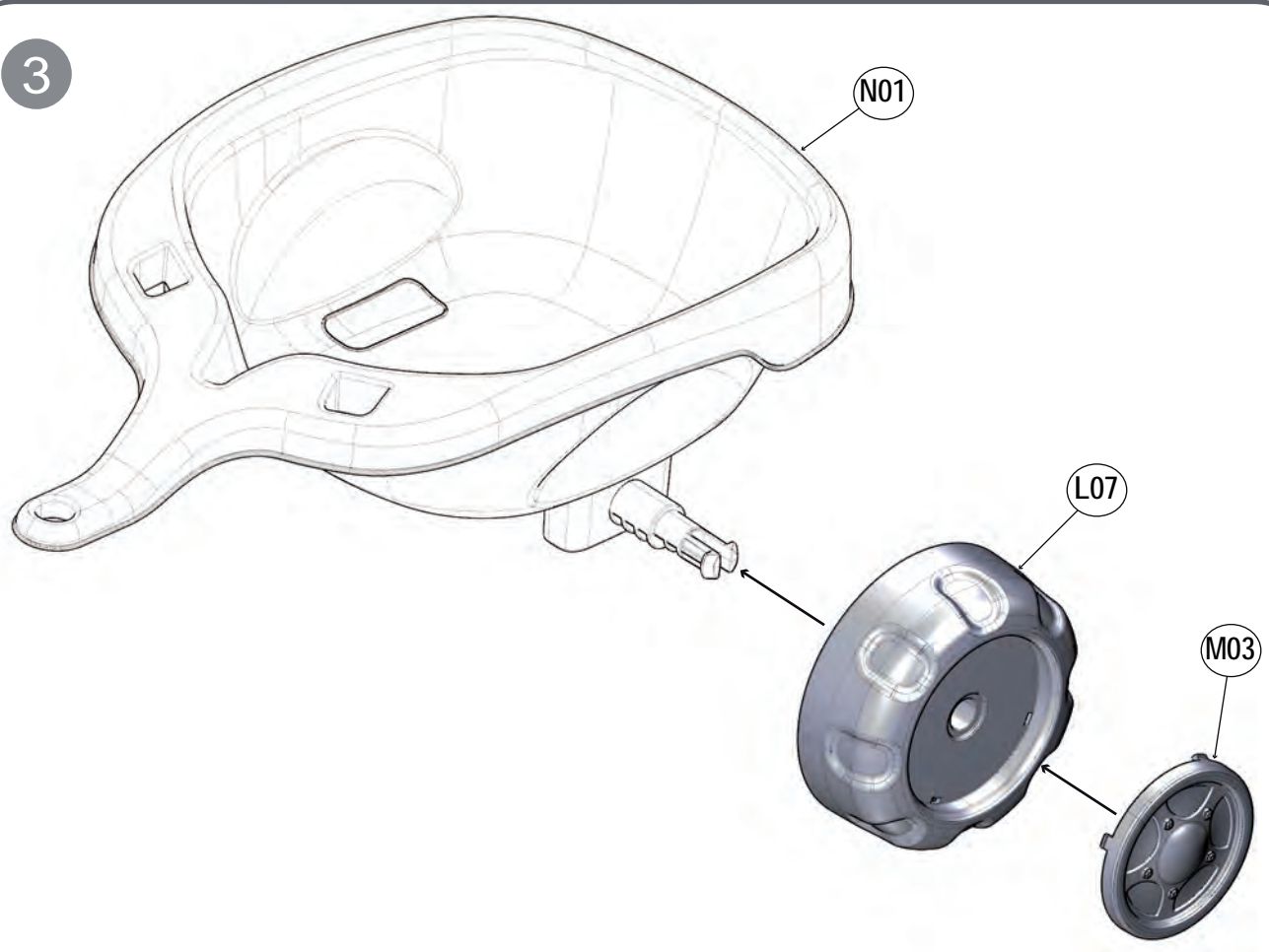

4

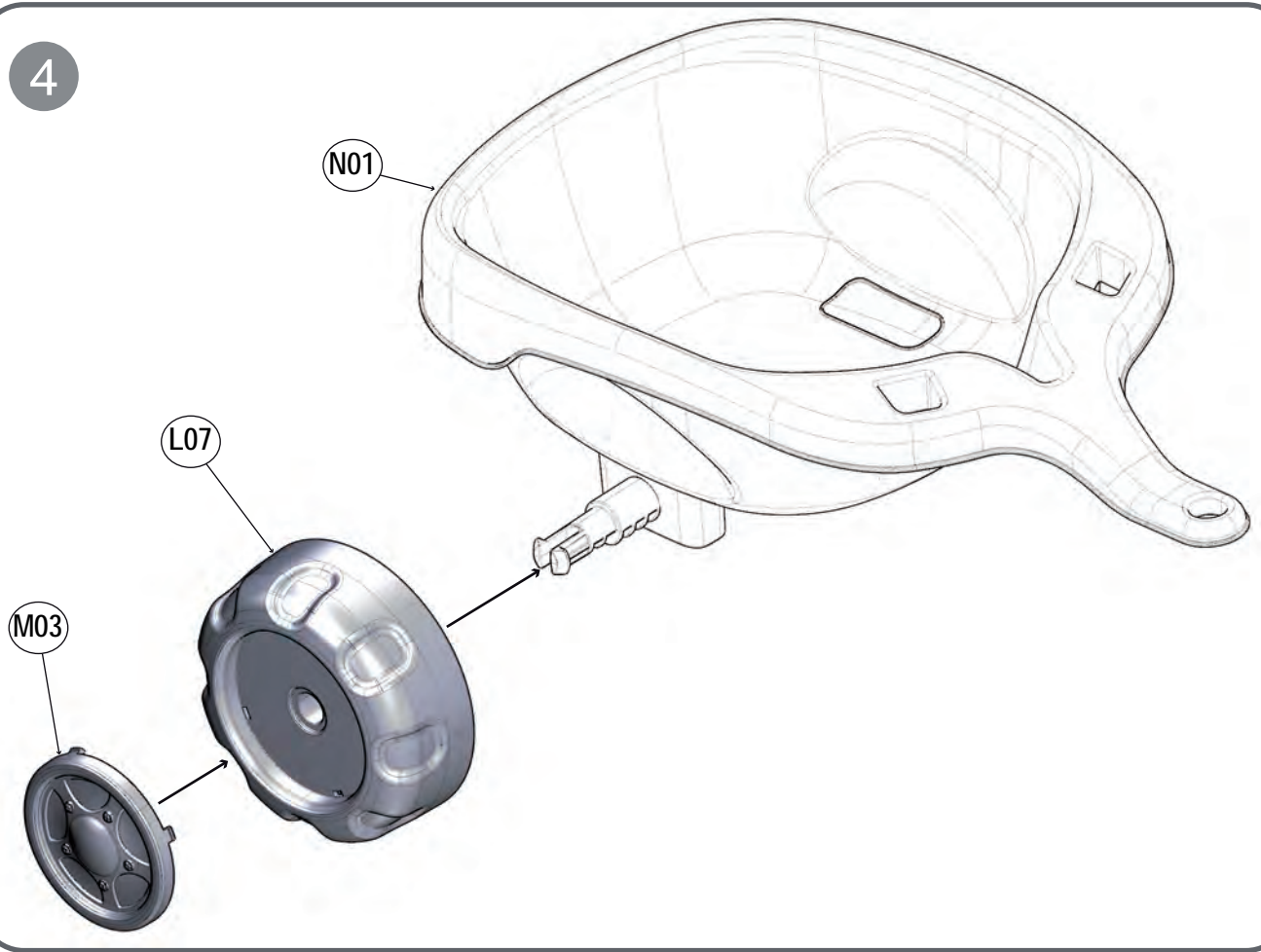



An issue with one of our toys ? Please fill this form and send it to us, we'll do all the rest !
Un problème avec un de nos jouets ? Complétez ce formulaire et envoyez le nous, on s'occupe du reste !

By email to / Par email à : contact@falk-toys.us | By fax / Par fax au : (630) 377 2295

Request date
Date de la demande :

Concerns parts still under warranty
SAV Sous Garantie

Concerns parts out of warranty
SAV Hors Garantie

Who are you ?
Qui êtes-vous ?

Full Name / Nom Prénom :

Full Address / Adresse complete :

Postal Code / Code Postal : City / Ville :

Country / Pays :

Company / Société :

Phone number / Telephone :

E-Mail address / Adresse e-mail :

Please describe your toy

Quel est votre jouet ?

Item reference ⁽¹⁾ / Reference du produit :

[Please join a picture if possible / Joindre une photo si possible]

Date of purchase ⁽²⁾ / Date d'achat :

Batch number ⁽³⁾ / N° de lot :

1. Falk reference only (printed on the packaging).
Référence Falk uniquement (voir packaging).
2. Please add proof of purchase.
Joindre une preuve d'achat.
3. Batch N° is on a white sticker with a QR Code on the packaging.
Le N° de lot se trouve sur une étiquette blanche avec QR Code collée sur l'emballage.
4. If your product is a tractor + trailer set, thanks in advance for letting us know whether this request concerns the tractor or the trailer.
Dans le cas d'un combiné tracteur + remorque, merci de préciser si la lou les pièces man-quant es concernent le tracteur ou la remorque.
5. For all demand concerning out of warranty parts, a quotation will be sent out to your attention for approval. Shipment will then be done after payment has been received.
Pour les pièces détachées hors garantie, un devis est établi et envoyé au client par e-mail pour accord. Aucune commande de produit hors garantie ne sera envoyée avant réception du paiement.

Tell us what's wrong?⁽⁵⁾

Quel est le problème

Oops ! A part is missing ⁽⁴⁾ / Oups ! Il manque une pièce
 Tractor / Tracteur Trailer/Remorque Other / Autre

Ouch ! Parts have been damaged during transport
Aïe ! Il ya eu dela cassependant le transport

Worn out parts due to long hours of play
Pièces uséespar des centaines d'heures de jeux

Other / Autres
[To clarify / Préciser]

Any additional information could help to handle your case. ⁽⁵⁾

Plus d'informations utiles à nous donner ? Cela facilitera le traitement de votre demande !